

Concluding Remarks

It is generically useful to have some means of estimating the relative surface areas of the catalytically active ingredients in supported catalysts. For supported metals, the methodology for using selective chemisorption of gases for this purpose is well-developed and broadly accepted. Extension of selective chemisorption techniques to transition-metal oxides and sulfides would fill a present void.

Oxygen chemisorption at low (subambient) temperatures on prerduced chromia or molybdena appears to be a suitable method for these materials supported on alumina or silica. Comparable measurements on the unsupported oxides afford the possibility of achieving

absolute measurements of specific surface area, although questions of interpretation remain. Specific chemisorption of oxygen also appears suitable for the characterization of supported molybdenum sulfide catalysts, which are extremely important for hydro-sulfurization and coal conversion processes.

Interest in the methodology of such characterization techniques has led, during the past decade, to substantial international and national efforts to develop broadly useful, standardized test procedures. The perceived common interest of both developed and developing nations is responsible for great progress in standardized methods both in the U.S. and in Europe.

Registry No. O₂, 7782-44-7; Cr₂O₃, 1308-38-9; MoO₃, 1313-27-5.

Asymmetric Hydrogenation

WILLIAM S. KNOWLES

Monsanto Agricultural Research Division, St. Louis, Missouri 63167

Received May 28, 1982 (Revised Manuscript Received November 22, 1982)

The need to resolve racemic mixtures whenever an asymmetric center is produced has long been a serious limitation to the synthetic chemist. In industry, where usually only one isomer is needed, the problem is particularly severe since resolution, with its numerous recycle loops and fractional crystallizations, is an inherently expensive process. In most cases when a large volume of an optically active substance is required, the chemist has resorted to biochemical routes even though efficient procedures to obtain the DL mixtures are often available. Specific examples are monosodium L-glutamate, L-lysine, and L-menthol, which are all manufactured by biochemical processes¹ on a large scale.

In order to beat "the bug" one needs a catalyst that, when an asymmetric center is formed, directs a reaction to give a predominance of one isomer. For this purpose the 100% efficiency achieved by enzymes would not be necessary to have something of real use. Two developments that occurred in the mid-sixties offered a very attractive approach toward making such a catalyst.

The first was the discovery by Wilkinson² of chlorotris(triphenylphosphine)rhodium, [RhCl(PPh₃)₃], and its amazing properties as a soluble hydrogenation catalyst for unhindered olefins. Homogeneous catalysts had been reported before, but this was the first one that compared in rates with the well-known heterogeneous counterparts.

The other development was the discovery of methods for preparing optically active phosphines by Horner and by Mislow.³ The basic strategy was to replace the triphenylphosphine in Wilkinson's catalyst with a known asymmetric phosphine and hydrogenate a prochiral olefin (eq 1).

William Knowles received his Ph.D. at Columbia University in 1942. He has been in various research assignments in Monsanto ever since and is now a Distinguished Fellow in the Agricultural Research Division. His interests have included a variety of organic chemical processes. In recent years he has spent most of his time on asymmetric catalysis.

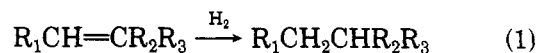

The validity of this thinking was soon verified by using the known methylpropylphenylphosphine and reducing substituted styrenes⁴ (eq 2).

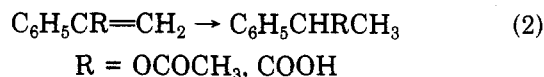

A modest but definite enantiomeric excess (ee) was obtained, and the problem now became one of finding a proper match between ligand and substrate to get synthetically useful efficiencies. As it turned out, good results were achieved only with more highly functionalized substrates than the original models, though the phosphine ligand structures that work well have remained even to this day quite simple, especially if we consider that the job they are doing is usually reserved for enzymes. The best substrate is an enamide precursor of α -amino acids, which is fortunate, since if one had a choice of systems for generating asymmetry one could hardly select a more important area than these protein building blocks.

When a bis(phosphine) ligand called DiPAMP⁵ (III) complexed with rhodium was used, the asymmetric catalysis in eq 3 was accomplished in quantitative yield with an excess of the desired isomer over the ra-

(1) K. Yamada, S. Kinoshita, T. Tsunoda, and K. Aida, "The Microbial Production of Amino Acids", Wiley, New York, 1972.

(2) J. A. Osborn, F. H. Jardine, J. F. Young, and G. Wilkinson, *J. Chem. Soc. A*, 1711 (1966).

(3) N. J. Gallagher and I. D. Jenkins in "Topics in Stereochemistry", Vol. 3, N. L. Allinger and E. L. Eliel, Eds., Wiley, New York, Chapter 1; W. E. McEwen, "Topics in Phosphorus Chemistry", Vol. 2, M. Grayson and E. J. Griffith, Eds., Interscience, New York, Chapter 1.

(4) (a) W. S. Knowles and M. J. Sabacky, *Chem. Commun.*, 1445 (1968). (b) L. Horner, H. Siegel, and H. Büthe, *Angew. Chem., Int. Ed. Engl.*, 7, 941 (1968).

(5) B. D. Vineyard, W. S. Knowles, M. J. Sabacky, G. L. Bachman, and O. J. Weinkauff, *J. Am. Chem. Soc.*, 99, 5946 (1977).

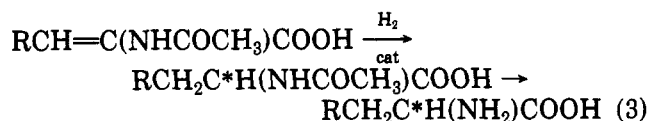

cemic mixture (ee) of 95%. This technology has become the basis for a commercial process for the amino acid, L-DOPA (3,4-dihydroxyphenylalanine), a drug used for treating Parkinson's disease.

Over the past decade work in this field has increased enormously, and numerous comprehensive reviews⁶ have been published. This account attempts to present an overview of the important aspects, including a discussion of ligands, reaction conditions, substrates, and, finally, an update on mechanisms.

Ligands

Since achieving 95% ee only involves energy differences of about 2 kcal, which is no more than the barrier encountered in a simple rotation of ethane, it is unlikely that before the fact one can predict what kind of ligand structures will be effective. In the beginning a lot of guesswork was needed, but in spite of these problems progress was fairly rapid after it was found that the rhodium-phosphine system worked much better on a highly functionated olefin such as α -acetamidocinnamic acid than on the original models.

With Horner's methylpropylphenylphosphine³ at 28% ee as a starting material, no improvement was achieved by varying the small, medium, and large groups.⁷ It was only by introduction of an *o*-methoxyphenyl as in PAMP (Figure 1) that there was real progress. Then, further conversion of the phenyl to a cyclohexyl resulted in CAMP (I)⁷ (cyclohexyl-*o*-anisylmethylphosphine). This product at 80–88% ee became the first commercial candidate used for the manufacture of L-DOPA. Finally, dimerizing PAMP to DiPAMP (III) gave the present optimum structure. Further obvious manipulations such as the dimerization of CAMP to DiCAMP lead to an inferior product that is typical of the surprises encountered in synthetic work in this field.^{8a}

At first it was expected that it would be necessary to have chirality directly on the phosphorus, but the discovery of DIOP (II),⁹ a bis(phosphine) joined by a chiral backbone, proved this reasoning to be wrong. DIOP, because of its easy synthesis from tartaric acid, rapidly became the best known ligand. The three structures (I, II, and III) (Figure 2) held sway for several years, but now the field has proliferated and it looks as though there is no limit to the number of highly effective ligands possible. The reviews⁶ contain numerous charts and diagrams showing the considerable variety of phosphines able to catalyze an efficient hydrogenation

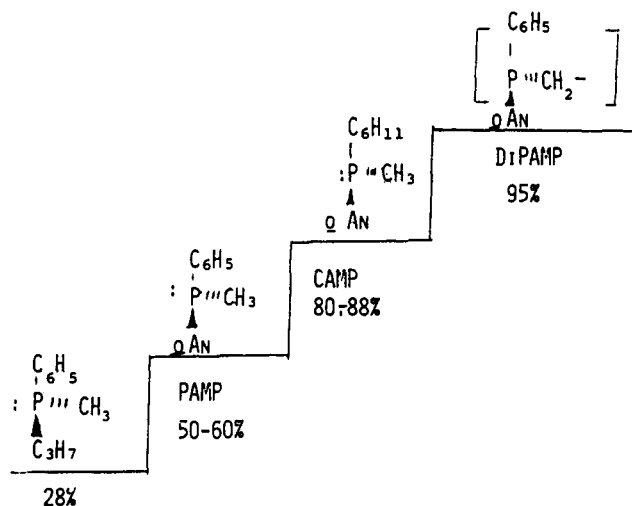

Figure 1. Genesis of phosphines.

when complexed with rhodium. Figure 2 simplifies the picture by taking a typical member of five different groups (IV–VIII), each of which has been subdivided into numerous derivatives and variants.

These structures except for I are all chelating bis-(phosphines). They all do the same job on the same type of substrate and on little else. They can be looked at when complexed with rhodium as a way of arraying four phenyl groups around a metal center in a chiral conformation.

Chiraphos (IV)^{6,8b,10} is a member of a group forming a five-membered chelate ring with rhodium. The tendency for the large methyl groups to occupy the unhindered equatorial position fixes the ring in a rigid conformation contributing to high catalytic efficiency. Even one methyl^{8b,10} or other alkyl is sufficient to give good results. The disubstituted cases like chiraphos are very slow, but the monoalkyls are much faster and nearly as efficient.

DiPAMP (III),⁵ which behaves very similarly to the Bosnich phosphines, has also been varied in a number of ways by using substituted aryl groups.^{8a} None of these variants offered any advantage over the parent material.

BPPFA (V)^{6,11} is the parent member of ferrocene-derived ligands. It has two kinds of chirality, one on the side chain and a second on the 1,2-substituted cyclopentadiene ring. Variation of the side chain as well as the ring chirality has generated a lot of different derivatives. With an alcohol-substituted side chain, the system can give high ee's for functionated ketones though at very slow rates.

BPPM (VI),^{6,12} like DIOP, is a seven-membered chelator derived from natural (2*S*,4*R*)-hydroxyproline. It can give high efficiency at very fast rates. Unfortunately, it gives unwanted D-amino acids and it turns out to be quite laborious to convert both asymmetric centers of hydroxyproline to the other antipode.¹³ The nitrogen can be substituted with a large variety of R groups, giving a potential for optimizing for a given substrate. In the absence of base, the efficiency of

(6) (a) J. W. Scott and D. Valentine, Jr., *Science (Washington, D.C.)*, 184, 943 (1974). (b) D. Valentine, Jr., and J. W. Scott, *Synthesis*, 329 (1978). (c) R. E. Merrill, *CHEMTECH*, 118 (1981). (d) V. Caplar, G. Comisso, and V. Sunjic, *Synthesis*, 85 (1981). (e) "Asymmetric Synthesis", J. D. Morrison, Ed., Academic Press, New York, Vol. 3: J. Halpern, Chapter 2; H. B. Kagan and R. E. Merrill, Chapter 3; K. Koenig, Chapter 4, in press.

(7) W. S. Knowles, M. J. Sabacky, and B. D. Vineyard, *Chem. Commun.*, 10 (1972).

(8) (a) W. S. Knowles, W. C. Christophel, K. E. Koenig, and C. F. Hobbs, *Adv. Chem. Ser.*, No. 196, 325 (1982). (b) B. Bosnich and N. K. Roberts, *ibid.*, No. 196, 337 (1982). (c) J. M. Brown, P. A. Chaloner, and D. Parker, *ibid.*, No. 196, 355 (1982).

(9) H. B. Kagan and T. P. Dang, *Chem. Commun.*, 481 (1971); *J. Am. Chem. Soc.*, 94, 6429 (1972).

(10) M. B. Fryzuk and B. Bosnich, *J. Am. Chem. Soc.*, 99, 6262 (1977); 101, 3043 (1979).

(11) M. Kumada et al., *Bull. Chem. Soc. Jpn.*, 53 1138 (1980), and references cited therein.

(12) K. Achiwa, *J. Am. Chem. Soc.*, 98, 8265 (1976).

(13) G. L. Baker, S. J. Fritschel, J. R. Stille, J. K. Stille, *J. Org. Chem.*, 46, 2954 (1981).

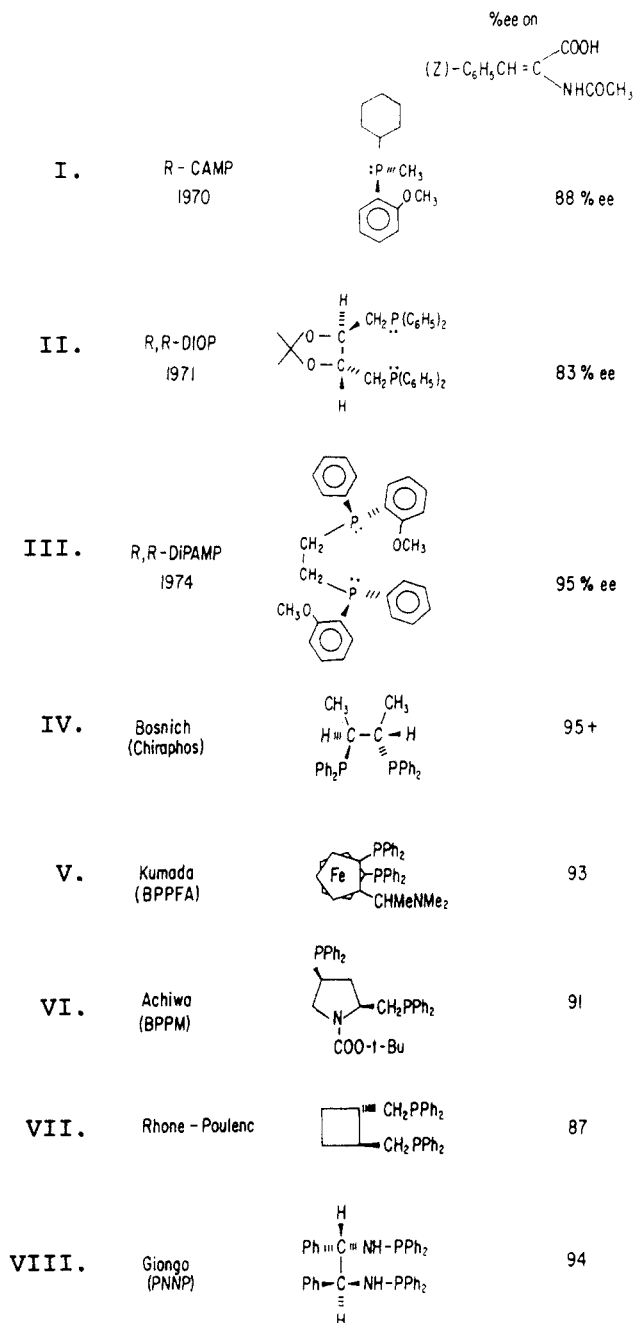

Figure 2. Phosphine ligands.

BPPM drops off drastically with pressure. With added triethylamine the catalysis is much slower but non-variant even up to 50 atm.

The Rhone-Poulenc structure (VII)^{14a,b} is actually a variation of DIOP where the acetonide ring has been replaced with an all-carbon cycle. Of the various possibilities, the four-membered ring is marginally optimal. Some further improvement of DIOP (II) has been achieved by replacing the phenyl group with 3-methylphenyl or 3,5-dimethylphenyl.¹⁵

The PNNP (VIII)^{6d,16} class of structures has been varied in a number of ways by several groups. The particular example chosen was characterized by easy

synthesis and its ability to give remarkably high efficiencies for such a flexible system. If the NH groups are replaced with CH₂, the resulting all-carbon skeleton is not particularly effective.¹⁷ Unfortunately, the P-N linkages are quite easily hydrolyzed or solvolyzed, and thus, for efficient use of the catalyst, the hydrogenations must be run in an inert media such as tetrahydrofuran.

Another group of ligands using a sugar fragment^{6d} for the chiral backbone can also be efficient but seems to offer no advantage over the above list.

Reaction

The reaction, as shown in eq 3, is simplicity itself.⁵ The catalyst may be prepared in situ by adding 2 equiv of ligand per mol of rhodium or a solid complex of the type [Rh(bis-ligand)(diene)]⁺BF₄⁻ may be used. Usual conditions are about 3 atm pressure and 50 °C with about 1000/1 mol ratio of substrate to catalyst in aqueous ethanol or 2-propanol. Generally, higher alcohols give marginally better efficiency than methanol. In many cases, by using the proper ratio of alcohol to water, it is possible to start with a slurry of substrate and end with a slurry of product. After filtration, the DL product that is made and the catalyst remain in the mother liquor. In all cases the efficiency drops with pressure, and this problem is particularly severe with the flexible seven-membered chelating phosphines and less so with the five-membered chelators. Use of triethylamine or other base to generate the anion results in considerably slower hydrogenations, but now the reaction is no longer susceptible to the pressure variable and the slow rates can be somewhat offset by running at 25–50 atm. In some instances with the anion it is only possible to get high ee's at 0 °C where reaction rates are impractically slow.^{8a}

Even in the best case some racemic product is made and must be separated. This separation is easy or hard depending on the nature of the optically active intermediate. If the racemic modification has a different crystalline form than pure D or L, then separation of the pure excess enantiomer will be inefficient. If one achieves a 90% ee, then it is possible to get out easily only 75 to 80% pure enantiomer. With lower ee's the losses become prohibitive. For such a system a catalyst of very high efficiency must be used. If, on the other hand, the racemic modification is a conglomerate or an equal mix of D and L crystals, then recovery of excess L can be achieved with no losses. Since the L and DL are not independently soluble a 90% ee easily gives a 90% recovery of pure isomer. In the commercial L-DOPA process, the intermediate (eq 3, R = 3-acetoxy-4-methoxyphenyl) is such a conglomerate and separations are efficient. Unfortunately, most racemic compounds are of the unfavorable type, and in developing amino acid processes juggling blocking groups to find an intermediate with conglomerate properties is an important consideration.¹⁸

The hydrogenation is poisoned by oxygen or peroxides and, for efficient catalyst usage, care must be taken to remove these impurities. Unlike heterogeneous catalysts, these soluble complexes do not catalyze the reaction of hydrogen or solvent vapors with oxygen and thus are not pyrophoric. For large scale using organic

(14) (a) Rhone Poulenc S.A., Fr. Patent 2230 654, 1974. (b) R. Glaser, S. Geresh, and M. Twaik. *Isr. J. Chem.*, **20**, 102 (1980).

(15) U. Hengartner, D. Valentine, K. K. Johnson, M. E. Larscheid, F. Pigott, F. Scheidl, J. W. Scott, R. C. Sun, J. M. Townsend, and T. H. Williams. *J. Org. Chem.*, **44**, 3741 (1979).

(16) M. Fiorini and G. M. Giongo, *J. Mol. Catal.*, **5**, 303 (1979).

(17) M. Fiorini and G. M. Giongo, *J. Mol. Catal.*, **7**, 411 (1980).

(18) J. Jacques, A. Collet, and S. H. Wilen, "Enantiomers, Racemates and Resolutions", Wiley-Interscience, New York, 1981.

Table I
Asymmetric Reduction of Enol Esters $\text{CH}_2=\text{C}(\text{R})\text{COOCH}_3$

ligand	R	% ee
I	COOC_2H_5	52
II	COOC_2H_5	27
III	COOC_2H_5	89
IV	COOC_2H_5	84
VI	COOC_2H_5	67
I	CF_3	28
II	CF_3	0
III	CF_3	77
IV	CF_3	38
VI	CF_3	10

solvents, this property is an important safety feature since it minimizes the hazard of solvent fires. Probably this sensitivity to oxygen poisoning has contributed to the slow rates observed in the early literature.

The asymmetric product usually comes out of the reaction mixture optically pure and can be deblocked by acid hydrolysis without appreciable racemization. The main problem with the amino acid route in eq 3 is the preparation of the enamide precursor. When R is aromatic the synthesis from the corresponding aldehyde is usually quite efficient, but when R is aliphatic condensation yields are so poor that the gain in avoiding resolution is often lost in the synthesis of the substrate.

Ligands like DiPAMP can be readily synthesized by using Mislow-type chemistry.⁵ In all cases it is, of course, necessary to achieve asymmetry by drawing on the natural chiral pool. For DiPAMP (III), L-menthol is used, and for DIOP (II), tartaric acid is used. Since the catalysts in the absence of oxygen or peroxide are very active, it is easily possible to make thousands of moles of product per mole of chiral agent. This enormous multiplier effect easily offsets the high cost of the catalyst.

Substrates

All the ligands in Figure 2 behave similarly on (*Z*)- α -acetamidocinnamic acid, but when one varies the substituents on the olefin, they can behave quite differently. When the free carboxyl is changed to a derivative such as an ester, an amide, or a nitrile, usually the five-membered chelators work quite well but often the seven-membered bis(phosphines) like DIOP become quite inefficient.^{14b} In order to get good results, the olefin must be in the *Z* configuration, which is related to *trans*-cinnamic acid.⁵ This is particularly true with aromatic substituents, but this limitation is not serious since base condensations usually give a *Z*-substituted olefin. In the aliphatic series, poor results with *E* still holds for all of the ligands except DiPAMP where highly efficient results can be obtained even with *E* structures.¹⁹

With the closely related enol esters (Table I) only the five-membered chelators (III and IV) work at all well,²⁰ and if one modifies these substrates further by substituting a trifluoromethyl group for the carboxyl, then only DiPAMP (III) is efficient.²⁰ It seems that whenever an olefin substrate has the capability of forming chelate rings with a metal, then DiPAMP (III) is the

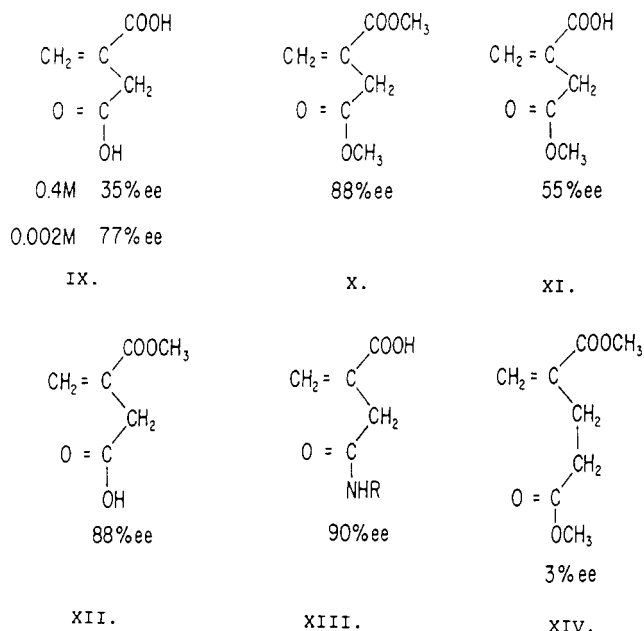
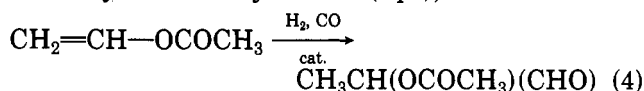

Figure 3. Asymmetric hydrogenation of itaconic acid with DiPAMP.

most generally applicable ligand, with the other five-membered chelators being a close second.

If one considers simple olefins such as α -phenylacrylic acid or substituted prochiral styrenes (eq 2), then DIOP is the best choice though even here ee's of only 60–65% are achievable. For other reactions, such as the hydroformylation of vinyl acetate (eq 4), DIOP derivatives



are also the best, but here, to achieve results approaching 50%, a 6-fold excess of ligand is needed,^{8a,21} and there is no longer a specific stoichiometry between the rhodium and the ligand. Similar results are reported for hydroformylation of styrene.^{6b,c}

The sensitivity of the hydrogenation to chelation can be demonstrated by a study of the asymmetric hydrogenation of itaconic acid,²² a methylene analogue of enamides, using DiPAMP. Figure 3 shows that hydrogenation of the free acid at 0.4 M concentrations gives only 35% ee. Dilution to 0.002 M, where intermolecular hydrogen bonding is not important, raises this value to 77%. The dimethyl ester (X), which has no opportunities for hydrogen bonding, goes nicely. The half-ester on the methylene carboxyl (XI) is inferior, whereas the other half-ester (XII) works very well. Presumably, the ability of the free carboxyl in XI to hydrogen bond to the ester carbonyl competes with chelation sufficiently to give poor results. Use of an amide (XIII) that is known to bond efficiently with metals²³ tips the balance in favor of chelation to give high yields. Finally, the next higher homologue (XIV) turns out to be ineffective.

Chelation by itself gives fast hydrogenations but is not enough for efficient results. It is necessary for the olefin to have in addition a carboxyl function or some other electron-withdrawing group (Figure 4)⁵. If this

(19) J. W. Scott, D. D. Keith, G. Nix, D. R. Parrish, S. Remington, G. P. Roth, J. M. Townsend, D. Valentine, and R. Yang, *J. Org. Chem.*, **46**, 5086 (1981).

(20) K. E. Koening, G. L. Bachman, and B. D. Vineyard, *J. Org. Chem.*, **45**, 2362 (1980).

(21) C. F. Hobbs and W. S. Knowles, *J. Org. Chem.*, **46**, 4422 (1981).

(22) W. C. Christofel and B. D. Vineyard, *J. Am. Chem. Soc.*, **101**, 4406 (1979).

(23) J. Halpern, Abstracts, ACS Joint Congress with Chemical Institute of Canada, May 29–June 3, 1977.

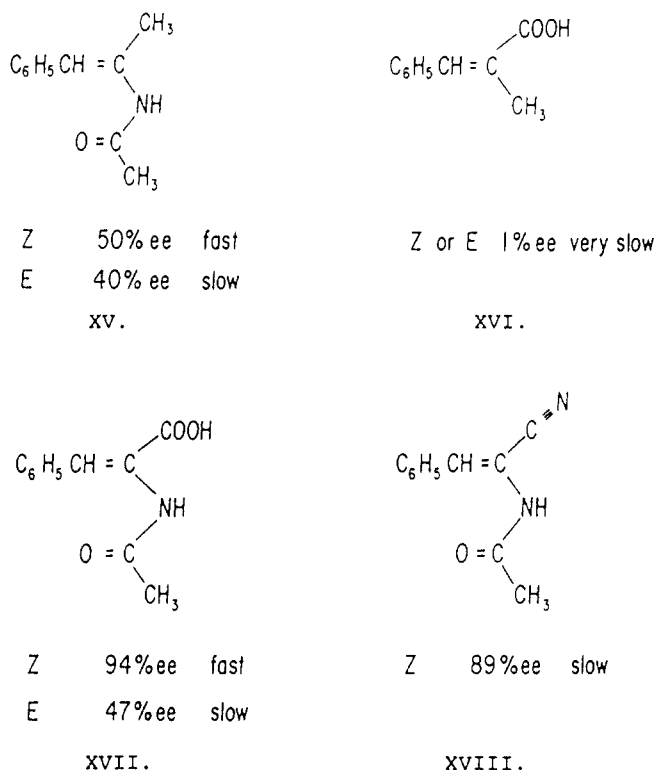

Figure 4. Chemical evidence for tie down with DiPAMP.

carboxyl is replaced by methyl, the *Z* form of XV gives fast hydrogenations but poor ee's and the corresponding *E* form of XV is both slow and inefficient. If one replaces the acyl amide with a methyl (XVI), hydrogenations are very slow and very inefficient, even though α -methylcinnamic acid is not a difficult material to reduce. As pointed out earlier, the *E* configuration (XVII) related to *cis*-cinnamic acid is both slow and inefficient in the aromatic series. The poor performance of *E* structures is probably caused by some subtlety in the hydrogen-transfer step and not by its inability to complex, since even simple amides bind quite firmly.²³

Earlier⁵ we have postulated that the carboxyl or its equivalent forms a third point of attachment, and there is some NMR evidence that this thinking may be correct.^{8c} If a tridentate species were necessary, then it would not be expected that cases where tie down is not readily possible such as the nitrile (XVIII) or the trifluoromethyl derivative (Table I) would give good results. Even though the third function in some cases may attach to the metal, particularly when the carboxyl salts are being reduced, its most important feature appears to be its ability to withdraw electrons.

A possible rationalization of the role of the third function is suggested by some recent data obtained out of both Halpern's²⁴ and Brown's laboratory.^{8c} The reaction is not only stereospecific but it is also regiospecific, and perhaps this regiospecificity is a necessary prelude to stereospecificity. As outlined in Figure 5, the enamide first forms a chelate with the metal, then oxidatively adds hydrogen either reversibly or irreversibly,^{8c} to make a dihydride, which so far has not been observed. Use of low-temperature NMR shows that the dihydride adds to the olefin to give a half-adduct (XXII) in a regiospecific manner with the metal attached to the α -carbon and the hydrogen to the β -carbon.^{8c,24} At room temperature, this complex goes rapidly to product, regenerating the metal catalyst. It

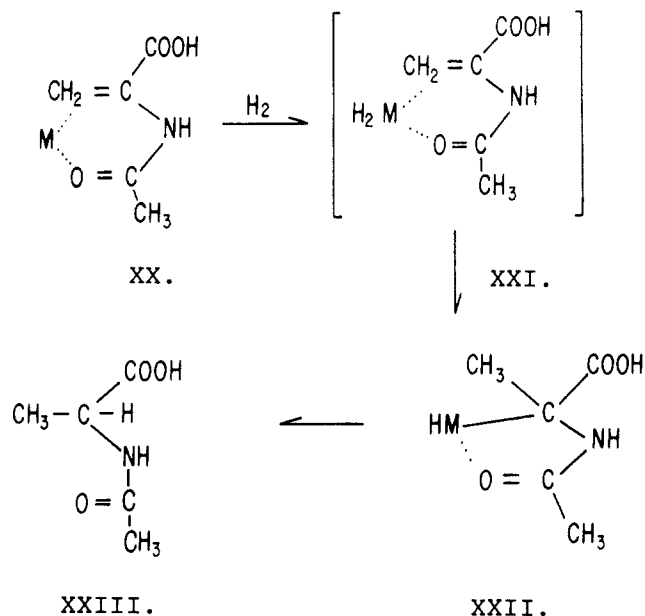

Figure 5. Regiospecificity.

is suggested that this rigid five-membered ring plays an important role in the ultimate stereochemistry. The carboxyl or other electron-withdrawing species would be expected to facilitate attachment of the metal at the α -carbon, and this influence may be its prime function. When fumarates are reduced where one has a carboxyl at both the α - and β -carbons, poor results are obtained.^{6d} In such cases good regiospecificity would not be expected. Actually, the electron-withdrawing carboxyl group is about the only R substituent that does not work well in the eq 3 sequence.

Theoretical Considerations

In science one can often use a phenomenon before one understands it. Such is the case with asymmetric hydrogenation, which was used commercially long before the details of the mechanism were worked out.

A considerable effort, mostly in the academic labs of Halpern²⁴ and Brown,^{8c} has been expended to clarify the mode of action, and today, in spite of its recent history, asymmetric hydrogenation has become one of the best understood catalytic reactions. With the hazard of oversimplifying what in detail is a delicate balance of equilibrium and rate constants, one can present a fair picture of how these systems operate. In order to work the substrate, the chiral phosphine and the hydrogen must all be on the metal at the same time. In this situation with (*R,R*)-DiPAMP the catalyst must show a considerable preference for adding hydrogen to the *re* face of the olefin. The origin of this preference with such simple ligand structure presents a challenging intellectual problem, and though there has been considerable progress the true nature of the transition state remains uncertain.

Figure 6 summarized what is known about the hydrogenation. The catalyst precursor (IX) in the presence of hydrogen loses cyclooctadiene and becomes a solvated complex containing no hydrogen. Then the substrate comes in forming a square-planar rhodium(I) complex (XX) with the diastereoisomers derived from the prochiral olefin in rapid equilibrium as compared

(24) A. S. C. Chan, J. J. Pluth, and J. Halpern, *J. Am. Chem. Soc.*, **102**, 5952 (1980).

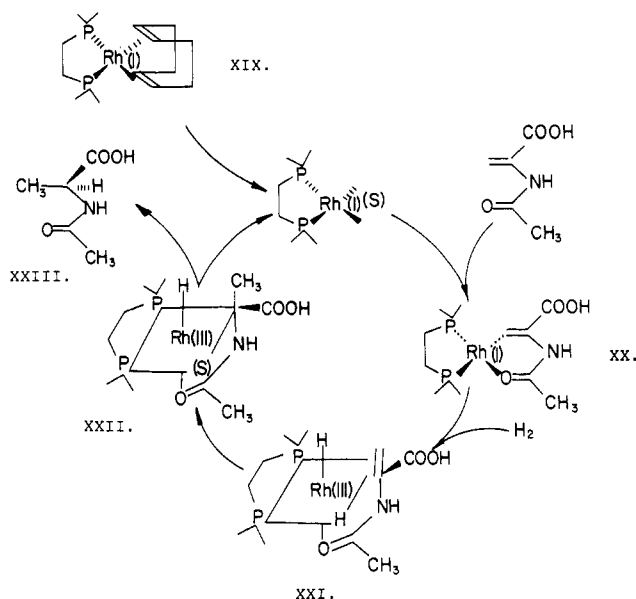

Figure 6. Mechanism summary.

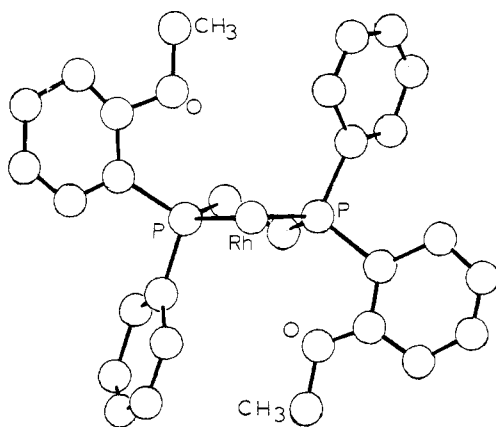

Figure 7. X-ray structure DiPAMP-rhodium complex XIX.

with the hydrogenation rate.^{8c} It was first tempting to conclude that the stereochemistry was controlled at this point, but the evidence rules out this simplified reasoning.^{8c,24} In the next stage hydrogen oxidatively adds to make an octahedral rhodium(III) complex (XXI). This dihydride, which has not been detected, has a transient existence and immediately converts to the half-adduct stage (XXII), described earlier in Figure 5, where the hydrogen is attached to the β -carbon and the metal to the α position. Finally collapse to product XXIII and regeneration of the solvated catalyst complete the cycle. Best evidence is that the stereochemical control occurs at either the hydrogen addition (XXI) or the rhodium alkyl hydride (XXII) stage.

All the successful bis(phosphines) including DiPAMP (III) when complexed with rhodium present an array of four aryl groups around a metal center. It is logical to conclude that a preferred conformation of these aromatic groups is the origin of the asymmetric bias.

X-ray crystal structure shows how these phenyls are arranged in the solid state and suggest at least a possible preferred conformation in solution. The structure of the (*R,R*)-DiPAMP catalyst precursor (XIX) is shown in Figure 7.²⁵ For the purpose of clarity the cyclo-

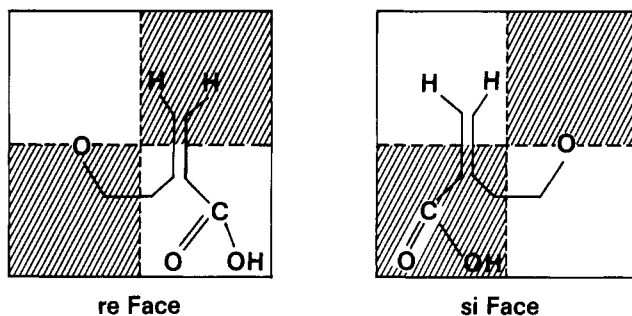

Figure 8. Quadrants.

octadiene has been deleted, and we are looking at the five-membered chelate ring along the phosphorus-rhodium-phosphorus plane much as an approaching substrate. It is noteworthy that the two methylenes are skewed above and below this plane and that the phenyl rings vicinal to these are exposing their face whereas the other two phenyls are on edge. A similar picture is obtained for the other five-membered chelators (IV).²⁵ With II and VI, which form seven-membered rings with rhodium, the situation is not so clear, but at least the aryl ring next to the skewed methylene is always face-on.²⁵

We have suggested⁵ that a linear prochiral substrate might lie more easily along the face-exposed aryls than the edge and that this might be the origin of the steric control. One can think of this system in terms of quadrant diagrams where quadrants 1 and 3 represent the unhindered face-on phenyls and the shaded squares, 2 and 4, the hindered edge-on aryls (Figure 8).²⁶ The linear prochiral acetamidoacrylic acid can easily lie on its *re* face with the carboxyl in an unhindered quadrant (3) (Figure 8) and pick up hydrogen to give L-alanine. On its *si* face the carboxyl will be in a hindered or shaded quadrant (4), and this form which gives D-alanine will not be preferred. For the higher amino acids and R group trans to the carboxyl as in a *Z* olefin can easily position itself in the other unhindered quadrant (1), while one that is *cis* or in the *E* configuration cannot.²⁶ This thinking provides a rational explanation for the observation that *Z* enamides work much better than their *E* forms.

The X-ray structure can be useful in predicting the configuration of the product from the configuration of the catalyst. If the catalyst complex is observed as in Figure 7 along the phosphorus-rhodium-phosphorus plane, and if the skewed methylene and its corresponding face-on aryl group above this plane are to the left, one gets L-amino acids; if to the right D-amino acids are obtained. In a single case where one has a 50/50 chance, such a prediction is not very impressive, but it works for all the bis(phosphines) and their many derivatives in Figure 2,^{25,26} where X-ray structures are either available or can be logically derived. In the case of BPPFA (V) no crystal structure has been reported and the rule cannot be applied. The single skewed methylene in VI leads to a correct prediction, and even the monophosphine CAMP (Figure 1) gives the same consistent edge-face X-ray structure, with a face-on

(25) W. S. Knowles, B. D. Vineyard, M. J. Sabacky, and B. R. Stultz, *Fundam. Res. Homogeneous Catal., Proc. Int. Workshop, 3rd, 1978, 3, 537* (1978).

(26) K. E. Koenig, M. J. Sabacky, G. L. Bachman, W. C. Christopf, H. D. Barnstorff, R. B. Friedman, W. S. Knowles, B. R. Stultz, B. D. Vineyard, and D. J. Weinkauff, *Ann. N.Y. Acad. Sci.*, **333**, 16 (1980).

cyclohexane ring to the left for L-amino acids.²⁶

The constraints of a preferred edge-face conformation of the aryl groups at the square-planar rhodium(I) stage XX cannot be very important since Halpern has obtained a crystal structure on a similar complex and shown that the prochiral olefin was lying on the metal with its carboxyl on the hindered quadrant and on the wrong face to give the observed hydrogenation product.²⁴ It is not unreasonable to suppose that only at the more crowded octahedral rhodium(III) stage XXI or XXII do these constraints become significant. A study of models on the transient dihydride XXI does not give any good clue as to the origin of the asymmetric bias even though there is a big change in the relationship of the chelated substrate and the bis(phosphine) going from a square-planar to an octahedral structure. A model of the half-adduct XXII, where the metal is bonded to the α -carbon in a five-membered ring (Figures 5 and 6) is more productive. Here, only the complex XXII derived from *re* face attachment has the bulky carboxyl in an unhindered quadrant on a face-on phenyl (Figure 8). In the product derived from *si* face attachment, the carboxyl will be repelled by the ortho hydrogen on the edge-on phenyl, making formation of D-amino acids more difficult. In summary, the greater ease of forming XXII with its *re* face on the metal rather than the *si* face provides a reasonable explanation of the steric control, but in order to accept this

explanation the hydrogenation step from XX to XXI would have to be reversible or the sequence from XX \rightarrow XXII concerted.^{8c} Whichever case turns out to be correct, it should be pointed out that it is quite remarkable that our knowledge of the catalytic mechanism has reached the point where such subtle features can be debated.

Conclusions

Asymmetric hydrogenation provides a viable alternative to biochemical methods for the preparation of α -amino acids, substituted lactic acids, and other materials derived from variation of the carboxyl function. It is most useful for aromatic amino acids since the precursor enamide is readily prepared. It is less useful in aliphatic cases where the starting olefin is difficult to make. The technique is particularly good for preparing isotopically tagged molecules where a high-yield, simple, last step is most desirable. Since it makes both antipodes with equal ease, it is the method of choice for D-amino acids where biochemical systems are not usually applicable.

Not only from a practical standpoint but also from a theoretical point of view, this hydrogenation has made a substantial contribution to our knowledge of homogeneous catalysis. In addition, its spectacular success has stimulated much work on asymmetric synthesis that is already beginning to bear fruit.^{6b}